

**Go Green**  
*Solar Power Solutions*

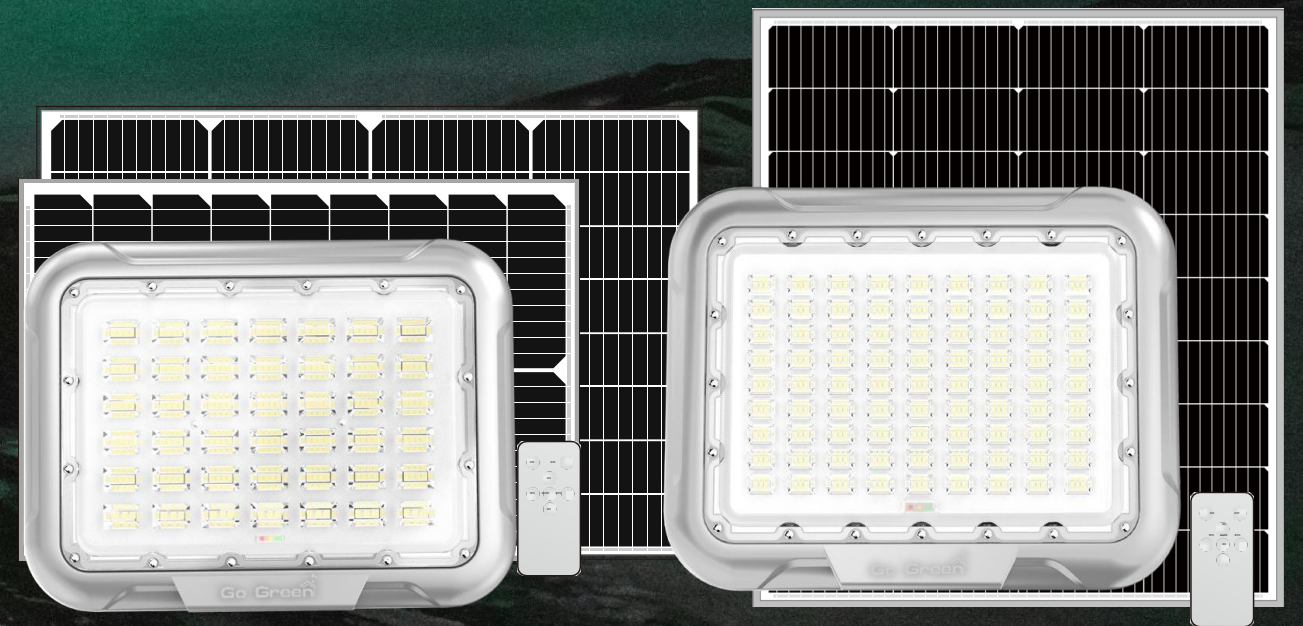



**SOLAR FLOOD LIGHT  
GGFL 2.0/GGFL 4.0  
70W/105W**

3200LM/5800LM



# GGFL 2.0/GGFL 4.0

## Solar Flood Light

-  Light energy charging
-  Always bright on rainy days
-  Wide lighting range
-  Clean Energy

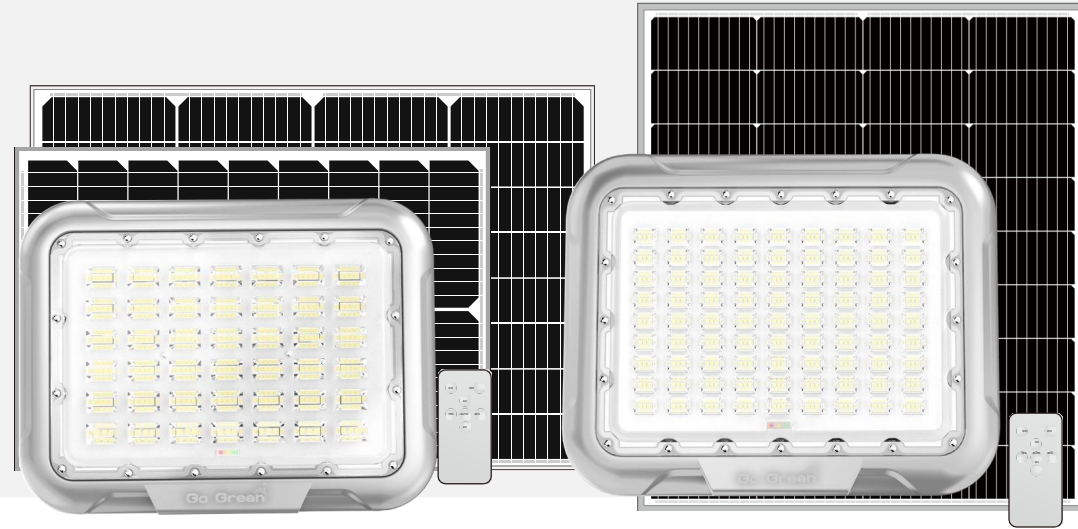

### Product Features

- **Imported High LED Lamp Beads**  
Imported high lumen LED chips with 100,000hrs life span
- **Aluminum Magnesium Alloy Lamp Case**  
High quality aluminum magnesium alloy, anti-corrosion and high heat dissipation
- **PC Outdoor Optical Lens**  
High light transmittance, high temperature resistance and aging resistance
- **3.2V LiFePO4 Battery**  
Super endurance, high and low temperature resistance, long cycle life

Model	GGFL 2.0	GGFL 4.0
Solar Panel	70W (Mono)	105W (Mono)
Panel Size	590x630x30mm	780x680x30mm
LiFePO4 Battery	3.2V/45(±5)Ah	3.2V/80(±5)Ah
Light Power	3200 lm	5800 lm
Installation Place	6+X/Intelligent power control, and can use remote control to adjust brightness and working mode.	
Usage	Indoor and outdoor Lighting or build the effect	

### Remote Control

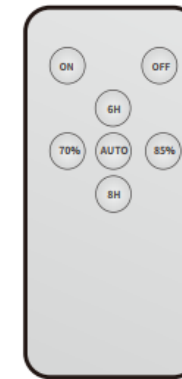

- ON key: Turn on
- OFF key: Turn off
- AUTO key: Reset, 6+X overnight lighting mode
- 6H key: Lights off after 6 hours
- ON key: Turn on
- OFF key: Turn off
- AUTO key: Reset, 6+X overnight lighting mode
- 6H key: Lights off after 6 hours

### Product Size: Lamp head size chart

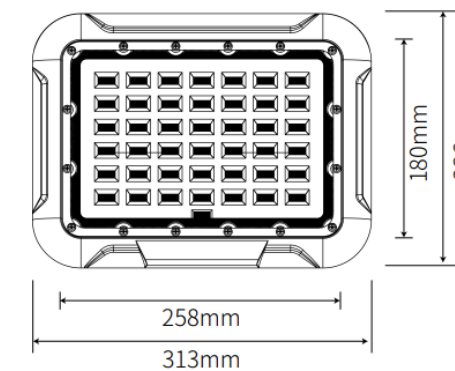

GGFL 2.0

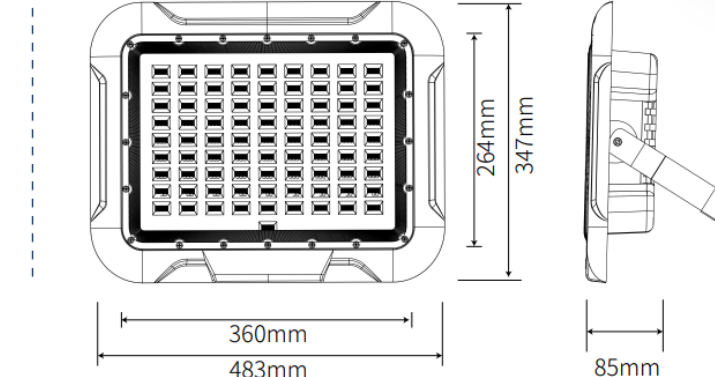

GGFL 4.0

**Go Green**  
*Solar Power Solutions*

# Solar Flood Light

